

VIEW	TOLERANCE	
	0-10	±1
	11-250	±5
	251-500	±10
	501-1000	±20
	1001-3000	±50
UNIT: mm	3001-5000	±100
	5001- >	±150

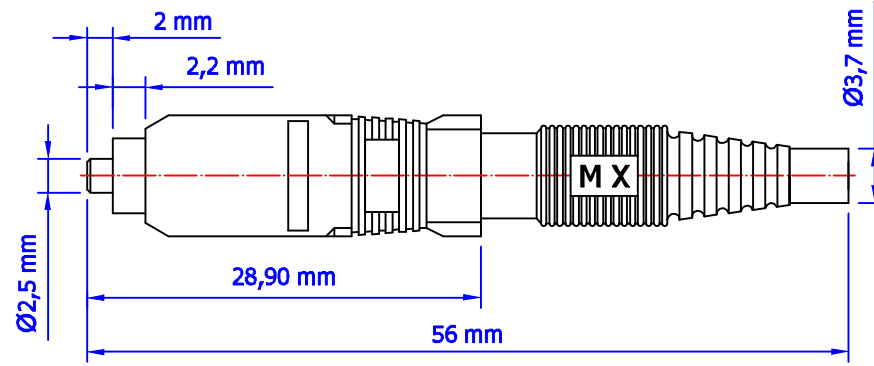
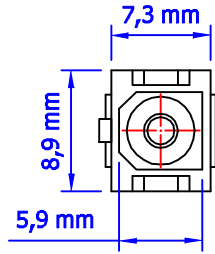
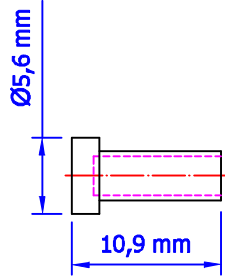

Date	16.03.2016	Rev.	-	Revision Detail		Rev.Dt.		Rev.by		Part No	SC/PC MM SX CONNECTOR		
Designed by	Yeşim AKSOY												
Checked by	Mevlüt GÜRBÜZ												
										Drawing Nr.	Scale	Sheet No	
										FO-0302MMP222MX	NONE	1/1	